

Panel mounted receptacle Cepex

Part number: 4819



MENNEKES
Elektrotechnik GmbH & Co. KG

Aloys-Mennekes-Straße 1
57399 Kirchhundem
GERMANY

www.MENNEKES.org

Product Description

- screw connection technology

Technical Details

Panel mounted receptacle Cepex	4819
Product serie	Cepex
Ampere	32A
Number of poles	4p
Clock position	7h
Nominal voltage AC	500V
Nominal frequency	50 - 60 Hz
Protection type IP	IP54
Contact carrier	standard
X-CONTACT	no
Connection	screw terminals
Contact screw drive	PZ2, slot
Pilot contact	without pilot contact
Pilot contact switch	no
Insertion direction	straight
Highly resistant to chemicals	no
Military version	no
Lockable	no
Labeling field	no
Tightening torque connection terminal	2 Nm
Strip length flexible conductor	8 - 10 mm
Strip length solid conductor	8 - 10 mm
Conductor cross-section min.	2.5 mm ²
Conductor cross-section max.	6 mm ²
Weight (net)	253 g
Packaging unit	8 pcs
Quantity per pallet	720 pcs

Panel mounted receptacle Cepex	4819
EAN / identification number	4015394315056

Permissible ambient conditions

	Min.	Max.
Permanent ambient temperature	-25 °C	40 °C
Average temperature over 24 hours		35 °C

Material properties

Housing	PC/ASA pearl white [similar RAL 1013]
Hinged lid	PC/ASA pearl white [similar RAL 1013]

Material resistance

The material resistance overview can be found on the website in the section “Knowledge” - “Product knowledge” - “Materials”.

Material and environmental properties

RoHS 2011/65/EU incl. 2015/863/EU	✓
POP regulation (EU) 2019/1021	✓

Regulations and Standards

Norm	DIN EN IEC 60309-2
Declaration of Conformity	CE

Dimensional Drawing

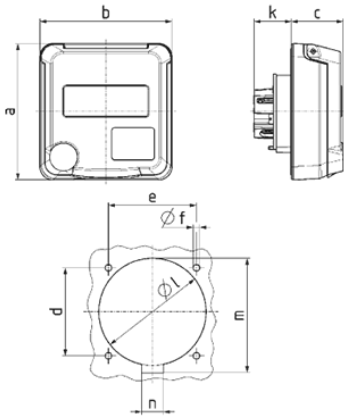

Drawing 1 MB 750	Amp. Poles	16			32		
		3	4	5	3	4	5
Dim. in mm	a	93	93	93	93	93	93
	b	90	90	90	90	90	90
	c	36	36	36	36	36	36
	d	60	60	60	60	60	60
	e	60	60	60	60	60	60
	f	4.5	4.5	4.5	4.5	4.5	4.5
	k	26	27	27	43	43	43
	l	68	68	73	73	73	73
	m	-	-	-	78	78	78
	n	-	-	-	15	15	15
Terminal for cond. cross section (mm ²) min.-max.		1.5	1.5	1.5	2.5	2.5	2.5
		-4	-4	-4	-6	-6	-6